

Newton Aviator User's Guide

Congratulations on your purchase of Newton Aviator, the premier flight planning application for the Newton. While we hope that the use of Newton Aviator is as intuitive as possible, we have prepared this guide to help you take advantage of all the capabilities of the product. This guide describes Newton Aviator version 1.2.

Installation

Newton Aviator consists of an application package, and one or more airport database packages of U.S. public-use airports. You can install as many of the database packages as your Newton's memory will allow. Note that installing more databases, in addition to consuming more memory, will also slow down any Find operations in Newton Aviator.

Disclaimer

Newton Aviator's airport databases are not warranted for accuracy, and *should not be used for navigation purposes.*

Also, if you use the aircraft type data that accompanies Newton Aviator, you should check it against your pilot's operating manual. It's not uncommon for an aircraft manufacturer to change certain specifications from one year to another — make sure the data you're using is appropriate for your aircraft.

Getting Started

After installation, the first step in using Newton Aviator is to enter some detailed information about aircraft you fly. (Some of the features of Newton Aviator are available only after you've entered this information into Newton Aviator. Once entered, this information is retained on your Newton and can be used for future operation of Newton Aviator.) Entering partial or incomplete information may disable certain features of Newton Aviator.

Get Acquainted

Tap the Aviator icon in the Extras drawer to start Newton Aviator. You'll first see an empty main screen. See Figure 1.

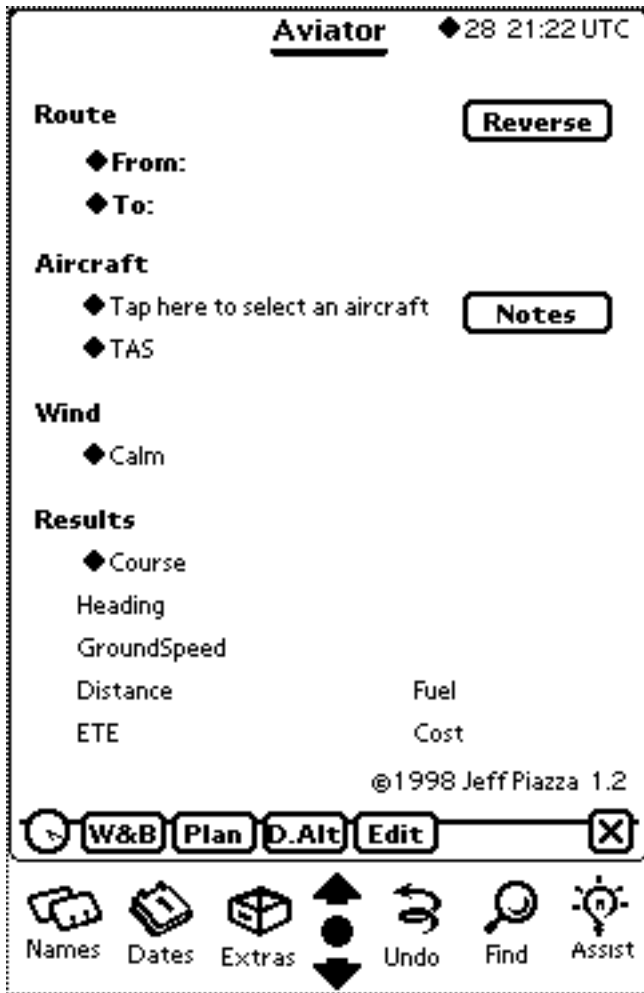

Figure 1
Newton Aviator Initial Screen

This is the main flight-planning screen, and provides access to all the other features of Newton Aviator.

Newton Aviator is most useful after you've entered some information about your aircraft.

Once entered, this information is retained and may be used for all your future flight plans.

Entering Aircraft Type Information

From the main screen, tap the Edit button, and select "Aircraft Types" from the pop-up menu. See Figure 2. A list of the aircraft types that Newton Aviator knows about appears. See Figure 3.



Figure 2
Edit Menu

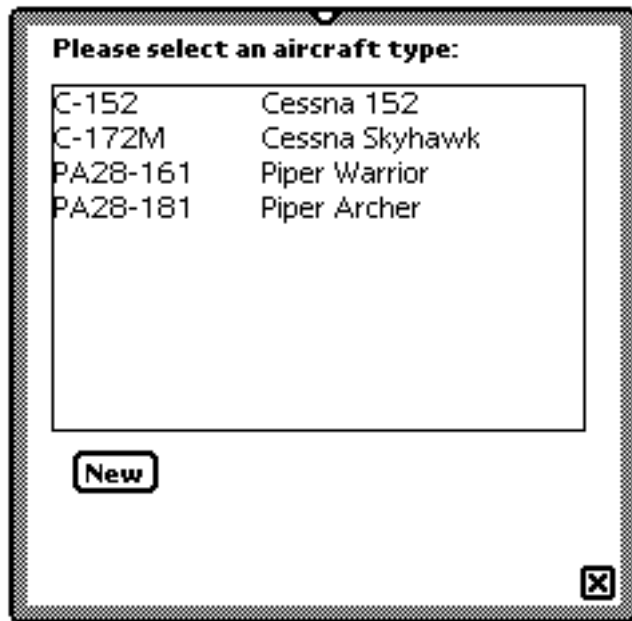

Figure 3
Aircraft Type Picker

Newton Aviator comes with type information pre-installed for some common aircraft types. (See Figure 3.) If the aircraft type for your aircraft appears on this list, you should verify the information with your pilot's operating manual. Then you can skip to "Editing Aircraft Information."

To create a new aircraft type information record, tap the **New button**, and the "General" screen for aircraft type information appears. See Figures 4 and 5. (You may edit an existing aircraft type by tapping on the line for that aircraft type. Use the scroll arrows if necessary to see more aircraft types.) **Enter the category, model name and type names in the spaces provided.** (As an example, one of the

predefined aircraft types has the model name "Piper Warrior"; the type for logbook is "PA28-161"; and the type for flight plan is "PA28".)

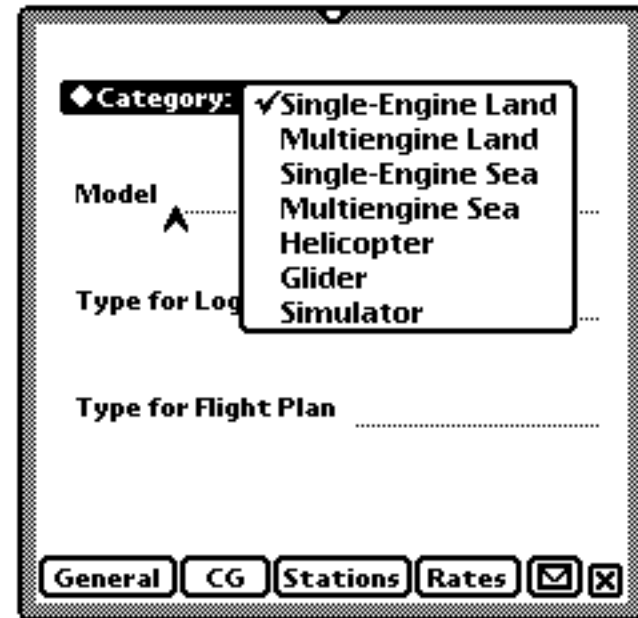

Figure 4
Selecting the Category for
a New Aircraft Type

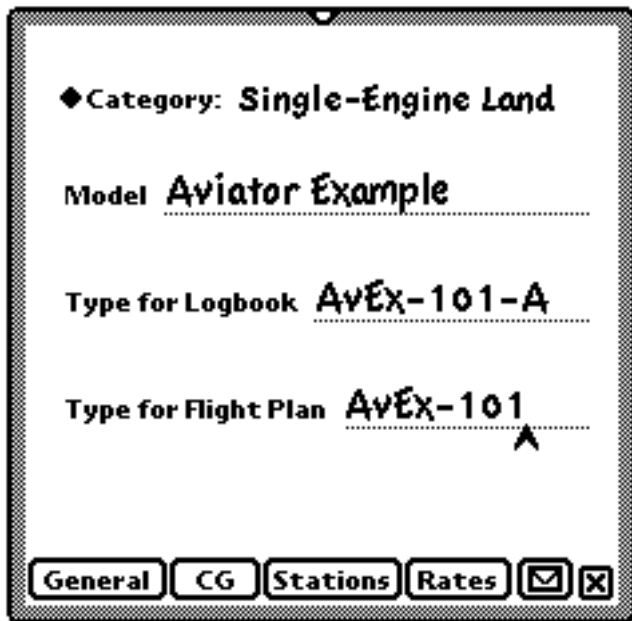

Figure 5
Aircraft Type Editor: General Screen

Tap the CG button to edit the center-of-gravity envelope information. First **select an operation category from the picker at the top of the window**. See Figure 6. CG envelope information may be entered for Normal, Utility, and Aerobatic categories.

The CG envelope is displayed and edited in the upper window, in a tabular format similar to what appears in the Limitations section of most pilot handbooks.

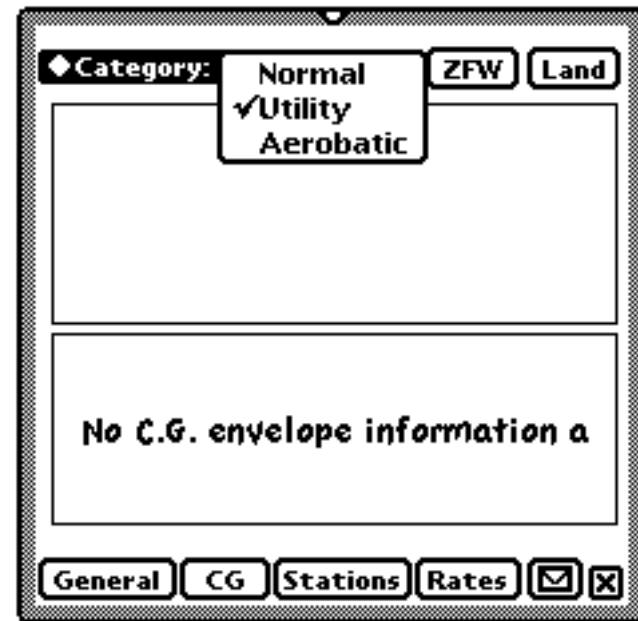

Figure 6
Aircraft Type CG Category

(The CG envelope is one of several parts of Newton Aviator that can be customized to use metric units instead of the default U.S. units. See the "User Preferences" section.)

Tap on an unused line in the upper pane to add a new table row. See Figure 7. Each row in the table gives the CG range at a particular weight; straight-line variation applies between rows in the table. The units and datum plane used to describe the fore and aft CG limits are arbitrary, but must be consistently used. Tap on an existing table row to edit that row. To delete a row, edit that row and erase any of the three fields.

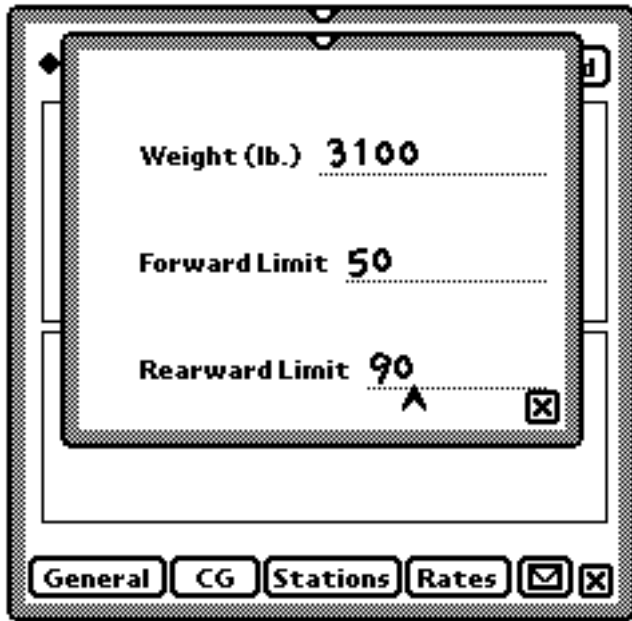

Figure 7
Entering a CG Table in
the Aircraft Type Editor

Some aircraft have a maximum “zero fuel weight” or landing weight limitation, in addition to the C.G. envelope per se. To enter such a restriction, tap the “ZFW” or “Land” button and enter the max. zero fuel weight or max. landing weight figure. These limits are displayed as dashed lines in the C.G. envelope. (See Figure 8.)

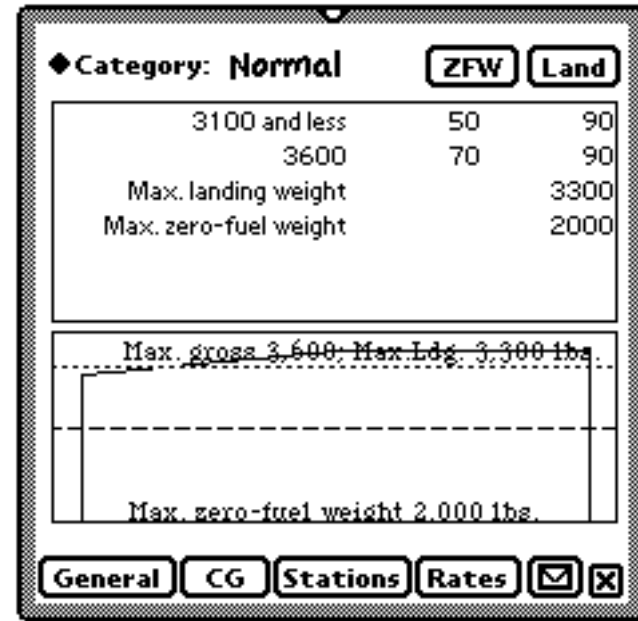

Figure 8
Aircraft Type Editor:
A Complete CG Table

Tap the Stations button to describe the locations of fuel tanks, passenger seats, and baggage areas. See Figure 9. The arm for each station must be described in the same units, and with respect to the same datum plane, as the CG envelopes in the previous step. **Tap the button for a particular loading station** to enter its arm and other information. See Figures 10, 11, and 12. When information has been entered for a station, its outline will appear in solid black on the picture of the aircraft.

The Oil station should be specified for those aircraft types which do not include engine oil in their Basic Empty Weight.

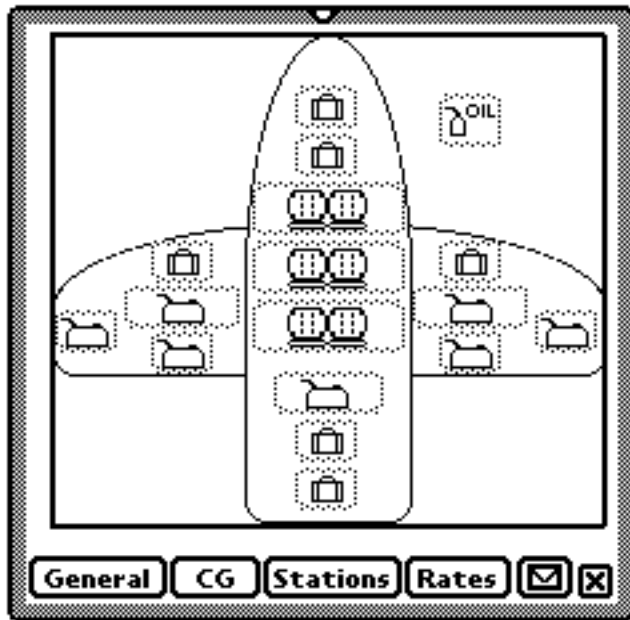

Figure 9
Aircraft Type Editor: Stations

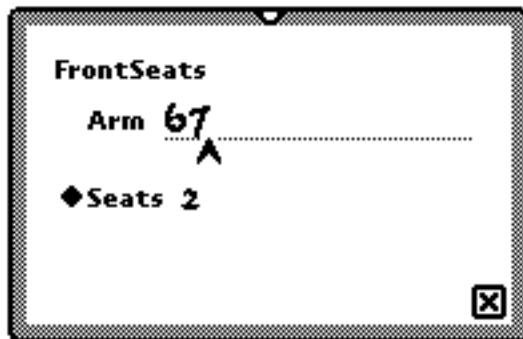

Figure 10
Aircraft Type Editor: Stations,
Seat Information

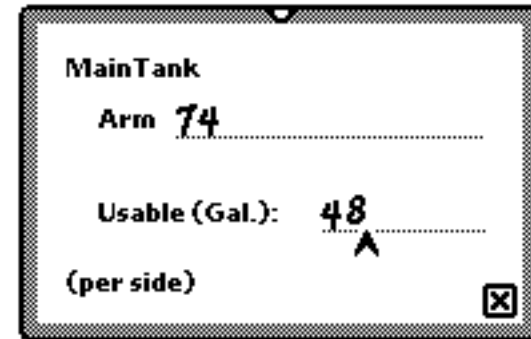

Figure 11
Aircraft Type Editor: Stations,
Fuel Tank Information

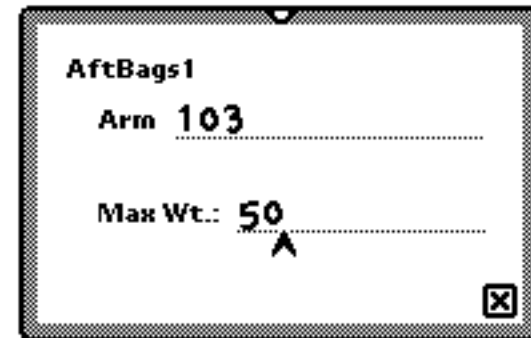

Figure 12
Aircraft Type Editor: Stations,
Baggage Compartment Information

Tap the Rates button to enter information about cruise speed, maneuvering speed, and fuel flow in the spaces provided. See Figure 13.

For your convenience, cruise speed and maneuvering speed may be specified in either nautical miles per hour (knots) or statute miles per hour (mph), according to the setting of the two radio buttons. Internally, however, all speeds are

recorded in knots, rounded to the nearest whole number. See Figure 14.

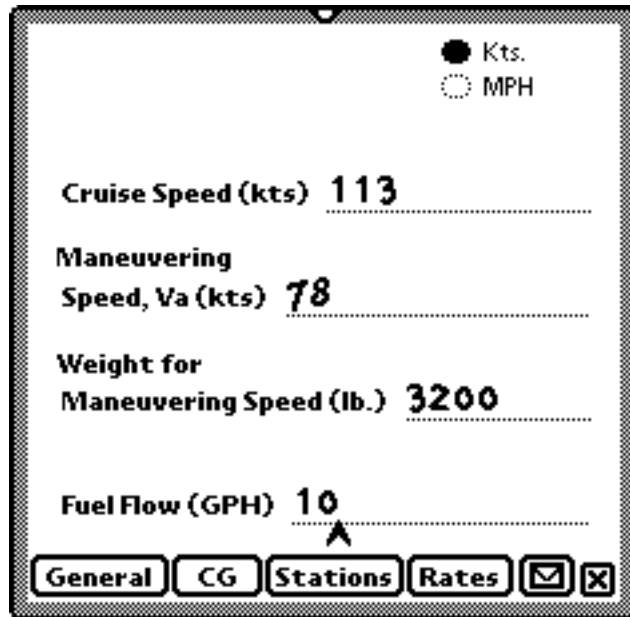

Figure 13
Aircraft Types: Rates, in Knots

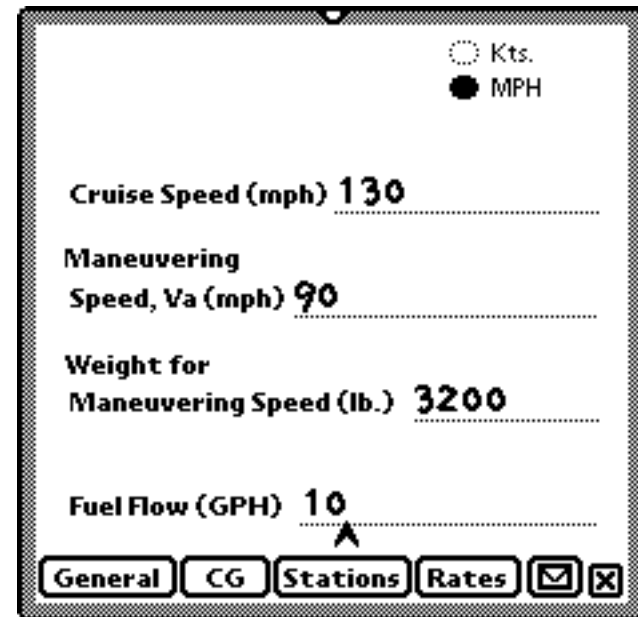

Figure 14
Aircraft Types: Rates, in MPH

The **action button** is the button containing an envelope icon; when tapped, it will display a pop-up menu of operations for the aircraft type record. See Figure 15. Aircraft type records may be deleted, duplicated, or “beamed” to another Newton via the Newton’s infrared port.

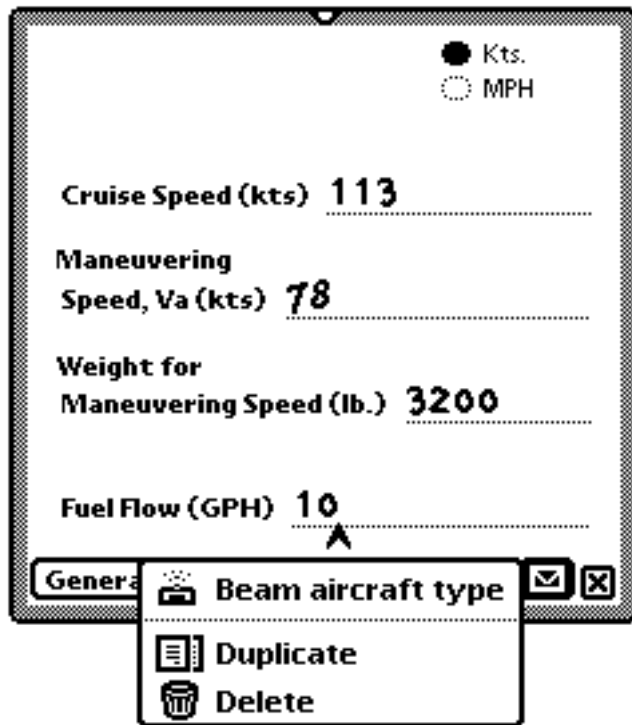

Figure 15
Aircraft Type Editor: Action Menu

The scroll arrows may be used to move through the aircraft type records. The overview button may be used to return to the aircraft type picker, from which you may select another aircraft type to edit, or create a new aircraft type¹.



Figure 16
The Scroll Arrows, Overview Button,
and Find Button

Tap the close box in the aircraft type editor to return to the main screen.

Entering Aircraft Information

From the main screen, tap the "Edit" button, and select "Aircraft" from the pop-up menu. A list of the aircraft that Newton Aviator knows about appears.

If no aircraft have been entered, the "General" screen for aircraft information will automatically appear; otherwise, tap **New** to create a new aircraft record. (To edit an existing aircraft record, tap on the line for that record. Use the scroll arrows if necessary to display more aircraft.) **Enter the registration ("N-number") and basic empty weight and arm** in the spaces provided. See Figure 17.

¹The scroll arrows and overview button may appear on a silkscreened bar across the bottom of the Newton screen. See Figure 16.

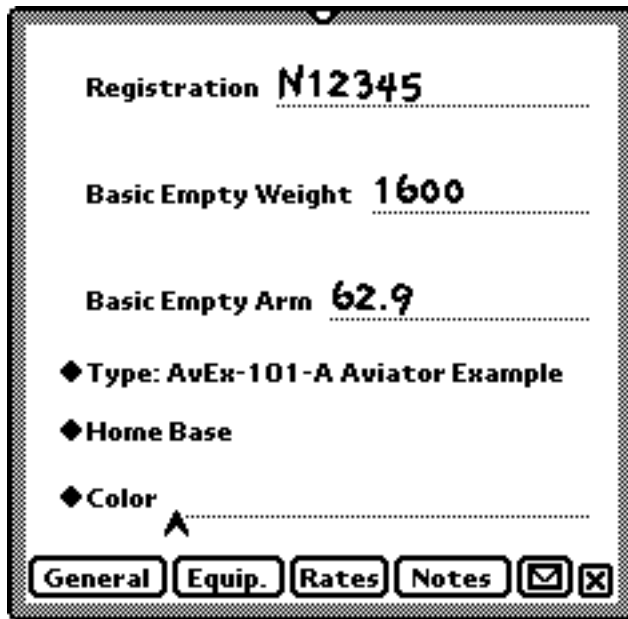

Figure 17
Aircraft Editor: General

Tap on "Type" to display a list of the available aircraft types. (See Figure 3.) From this list, select the appropriate aircraft type for this aircraft. **Tap the close box** to complete the selection.

To enter the aircraft color, you can write in the space provided, or **tap the word "Color" and select color(s) from the pop-up menu**. Multiple colors selected from the pop-up menu are separated by slashes ("/"). See Figure 18.

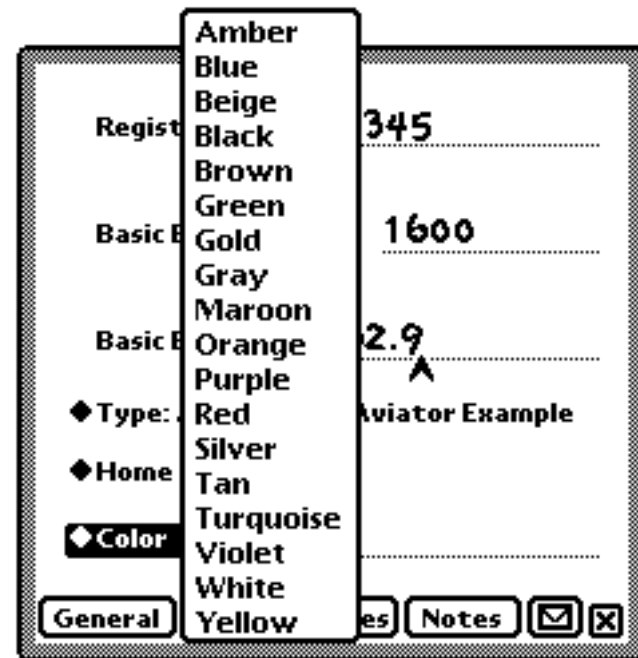

Figure 18
Aircraft Editor: General,
The Color Menu

Tap on "Home Base" to choose the home base airport for this aircraft; a pop-up menu of recently-selected airports will appear. If the desired airport does not appear on the pop-up menu, **tap "Select"** and an airport picker is displayed. See the "Selecting Airports" section for a complete description of the airport picker. (See Figure 19 and Figure 31.) Once the home base airport has been selected, **tap the close box** to return to the "General" aircraft information.

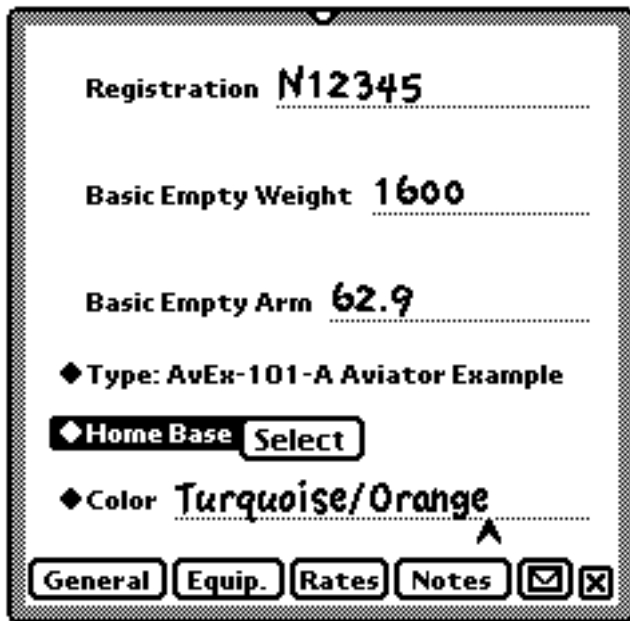

Figure 19
Aircraft Editor: General
Selecting a Home Base

Tap the Equip. button to edit the aircraft equipment. See Figure 20. The bottom four options are user-definable, as described in the "User Preferences" section. The equipment suffix to be used in flight plans is computed from the specified equipment.

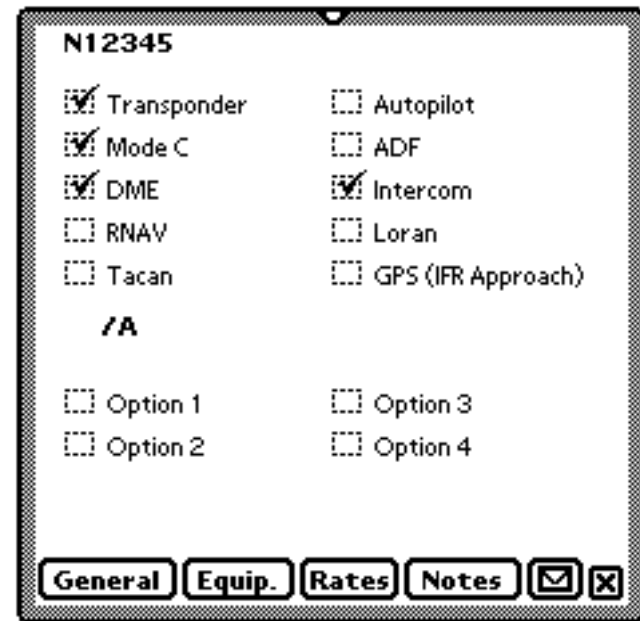

Figure 20
Aircraft Editor: Equipment

Tap the Rates button to edit cruise speed, fuel flow, and hourly (cost) rate information in the spaces provided. If the aircraft type provides default cruise speed and fuel flow values, these are indicated, and it's not necessary to enter these for an individual aircraft unless they're different from those for the aircraft type. (This is to account for, say, the effects of wheel pants on an individual aircraft's cruise speed.) See Figure 21.

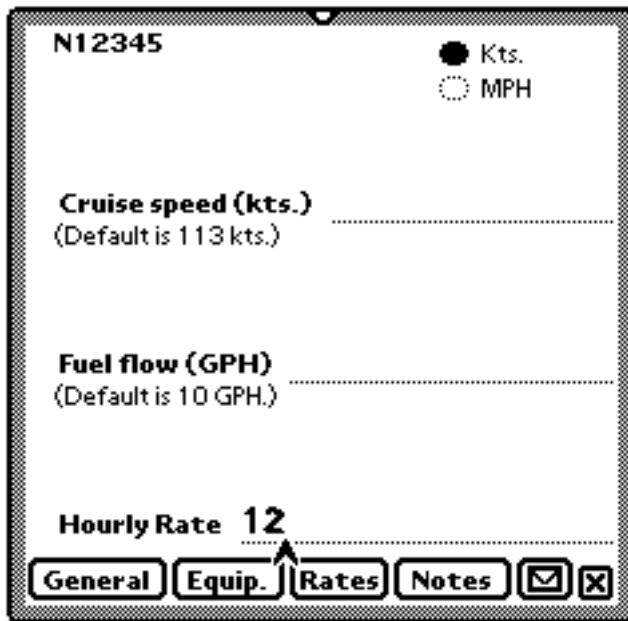

Figure 21
Aircraft Editor: Rates

Tap the Notes button to record your personal notes on the aircraft. See Figure 22. Use the scroll arrows to get more room for notes.

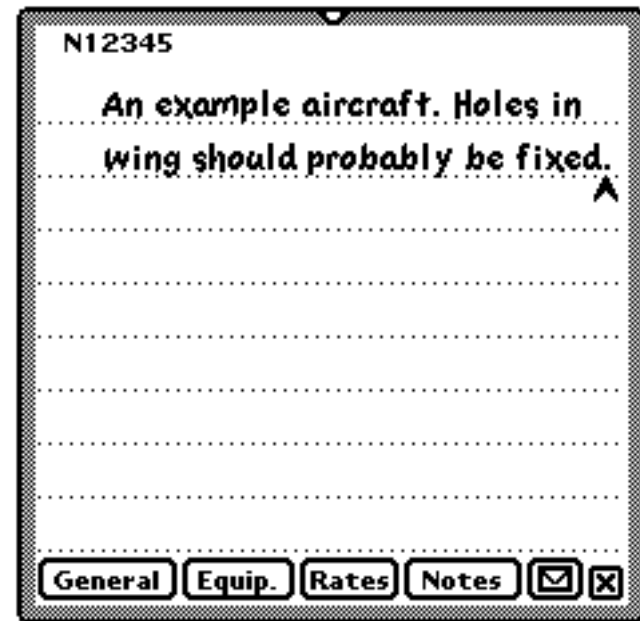

Figure 22
Aircraft Editor: Notes

The action button for the aircraft record is similar to that for aircraft types (see Figure 15). Aircraft records, like aircraft type records, can be duplicated, deleted, or beamed to another Newton.

Tap the close box to return to the main screen.

Entering User Airport Information

In addition to the airport database packages provided with Newton Aviator, or as an alternative, you may enter information about other airports or waypoints for which you wish to perform flight planning. If you use only U.S. public-use airports, you may skip this section and proceed to “Basic Flight Planning.” The remainder

of this section describes how to create and edit user airports.

From the main screen, tap the Edit button, and select the new “Airports” item from the pop-up menu. An airport picker will appear, restricted to the “User Airports” database. See Figure 23.



Figure 23
Airport Picker for Editing User Airports

If no airports have been entered, the airport editing screen will automatically appear; otherwise, tap New to create a new airport record. (To edit an existing airport record, tap on the line for that record. Use the scroll arrows if necessary to display more airports.)

When the airport editor appears, enter an airport identifier code, airport name, and the city in which the airport lies. Also, enter latitude and longitude, elevation, and magnetic variation for the airport. See Figure 24.

Every airport record must have an identifier code that is unique among the user-editable airports. If you do not enter an identifier, a numeric identifier will be generated for you.

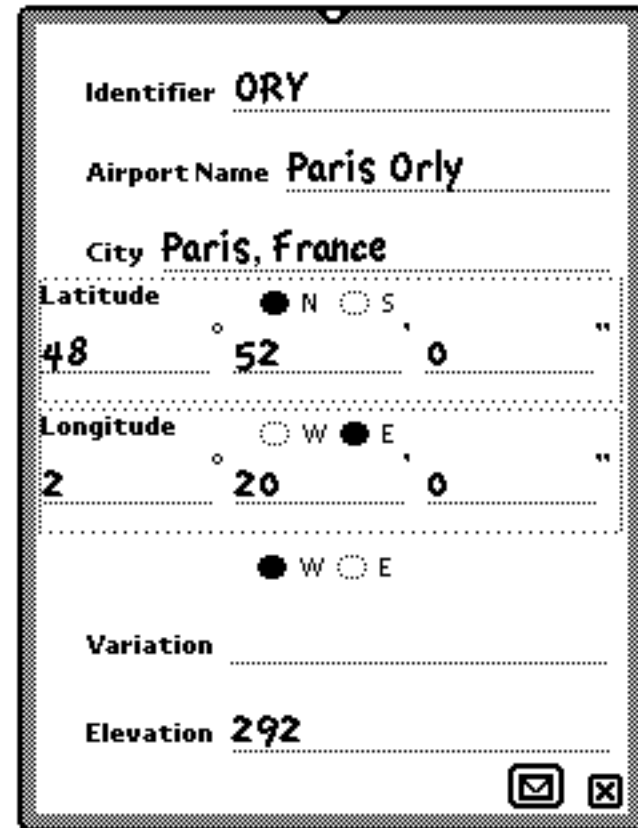

Figure 24
Airport Editor

Latitude and longitude are each described in degrees, minutes, and seconds, along with a hemisphere indication (North/South or East/West). Decimal points may be used in any of the numeric parts, so e.g. an airport's latitude could be described equivalently as N 33° 56.55' or N 33° 56' 33". (Internally, the four fields are combined into a single value; on redisplay, that value is separated into four fields. Thus the latitude or longitude may not redisplay in the same format you used to enter the data originally.)

The action button for the airport record is similar to that for aircraft types (see Figure 15). Airport records, like aircraft type records, can be duplicated, deleted, or beamed to another Newton. (Note: beaming an airport to a Newton which has Newton Aviator 1.0 will generally be unsuccessful, since Newton Aviator 1.0 does not support user-editable airports.) See Figure 25.



Figure 25
Airport Editor Action Menu

You may move forward or backward through the user airports by using the scroll arrows. You may return to the airport picker for editing or creating

other airport records by tapping the overview button. See Figure 16.

Tap the close box to return to the main screen.

Basic Flight Planning

To perform course and speed calculations for a direct flight, follow these steps on the main screen. First, **tap the diamond under "Aircraft"** to display an aircraft picker. **Tap on an aircraft** to see more detail information on a particular aircraft. If necessary, use the scroll arrows to see more aircraft. When an aircraft has been selected, **tap the close box** to return to the main screen. See Figure 26.

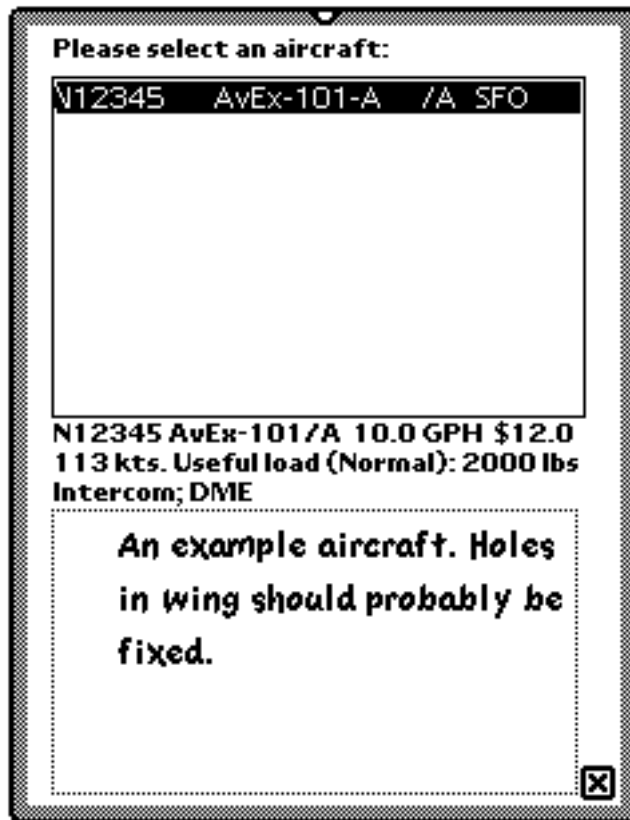

Figure 26
The Aircraft Selector

Tap on the "From" or "To" line to select an airport. See the "Selecting Airports" section (Figure 31) for a complete description of the airport picker.

Tap the diamond under "Wind" to enter the wind aloft. See Figure 27. In the view that appears, tap on the compass rose to set the (true) wind direction, and drag the slider to set the wind speed. Finally, tap the close box to return to the main screen. (The Calm button lets you quickly enter a no-wind

condition and return to the main screen in one step.)

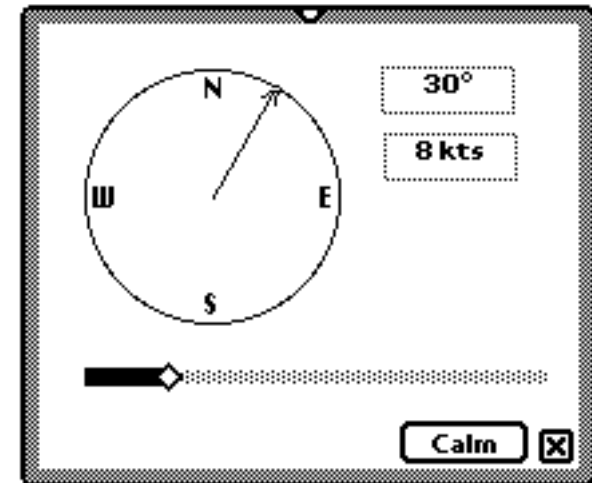

Figure 27
Setting Wind Information

Newton Aviator now displays true course, true and magnetic² heading, distance, groundspeed, and estimated time enroute (ETE)³ for a direct great circle route between the indicated airports. In addition, if fuel flow and hourly rate information is available for the selected aircraft, a total fuel

²Magnetic heading is based on the magnetic variation value associated with the "From" airport, unless you explicitly change the variation by tapping on the Var. button.

³Estimated time enroute is computed from the specified true airspeed, and includes no provision for time spent in climb or approach.

consumption estimate and flight cost estimate⁴ are displayed.

If your flight uses a different airspeed than the standard cruise airspeed for the selected aircraft, **tap the second diamond under "Aircraft"** to use another true airspeed value. See Figure 28. In the airspeed-setting view, **drag the slider** to set the airspeed. **Tap the + or - button** to fine-tune the TAS value. If you need to change the speed range, **tap one of the labeled arrows** above the slider. Finally, **tap the close box** to enter the new airspeed and return to the main screen.

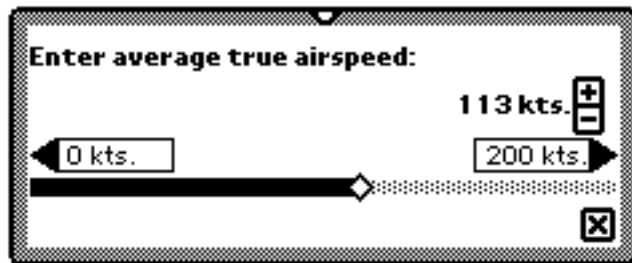

Figure 28
Setting True Airspeed

To perform E6B-style wind triangle calculations, **tap the "Course" label** to choose a different true course. See Figure 29. In the course selector view, **drag on the compass rose** to select a course (only multiples of 10° can be entered from this view). **Tap the close box** to enter the new course and return to the main

⁴The flight cost estimate includes an overhead figure to account for taxiing, climb, approach, etc., as described in the "User Preferences" section. The flight cost estimate may also be suppressed if the user preference for it is turned off.

screen. Alternatively, **tap the Cancel button** to return to the main screen without changing the course.

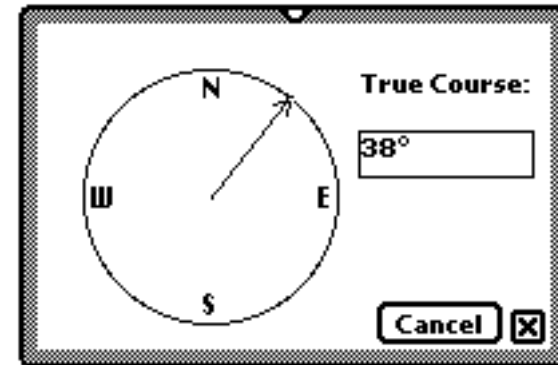

Figure 29
Setting True Course

For the return trip, **tap the Reverse button** to exchange the From and To airports⁵.

If desired, **tap the Notes button** to go directly to the notes associated with the currently-selected aircraft. (Other aspects of the aircraft record may also be edited from the displayed screen; see Figure 22 in the "Entering Aircraft Information" section.)

If you wish to use a magnetic variation value other than that associated with the departure airport, **tap the Edit button and select "Variation" from the pop-up menu** to open the variation picker. See Figure 30. **Tap the numeric keys** to enter the

⁵After pressing Reverse, the course may not change to an exact reciprocal. A true great circle route is flown with a constantly changing true course. The course shown is always the initial course for a route, i.e., the course at the "From" airport.

variation value, and then tap the **East** or **West** button. The small compass rose pictorially shows the currently-set variation⁶. Tap the **close** box to return to the main screen.

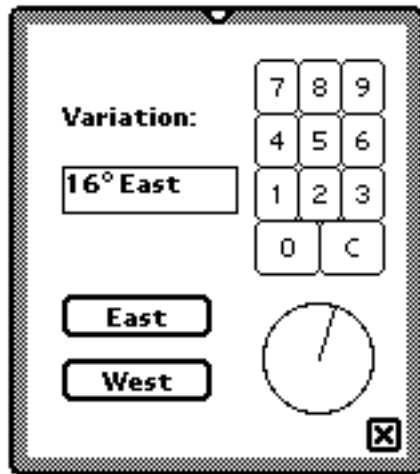

Figure 30
Setting Variation

Selecting Airports

Tapping the "Home Base" field of an aircraft record, or the "From" or "To" fields on the main screen, brings up a pop-up menu of recently-selected airports. To select another airport, tap **"Select"** from the pop-up menu to bring up an airport picker view. See Figure 31.



Figure 31
The Airport Picker

Tap the **region selector** at the top of the view to select the broad geographic region in which the airport is located. The airport data base is organized into regions, corresponding to the regions of the Airport and Facilities Directory (A/FD). You may load as many regions as your Newton's memory allows. Only the airports for the currently-selected region are displayed in the airport picker. See Figure 32.



Figure 32
The Airport Picker: Selecting a Region

⁶The line in the small compass rose should point in the same direction as the arrow in a VOR compass rose on an aeronautical chart.

Airports are listed alphabetically by city name. Use the scroll arrows to move through the displayed airports one screen at a time. Tap on the index strip to move more rapidly through the list of airports.

Tap an airport to select it, and to see more information about that airport. **Tap the close box** to complete the selection.

Alternatively, you can **tap on the Find button**⁷ to search through all the airports (in all loaded regions) for a particular word. See Figure 33. If an airport picker isn't already open, you can use the Find button to change the "To" airport in the main screen.



Figure 33
The Find Slip

Figuring Weight and Balance

If the currently-selected aircraft has weight and balance information, you can **tap the W&B button**

⁷The Find button, like the scroll arrows and overview button, may be on a silkscreened strip at the bottom of the Newton device's screen. See Figure 29.

to open the weight and balance screen. This will display an outline of the airplane, with buttons for each seat or baggage compartment. Below this display are sliders for usable fuel in each tank. See Figure 34.

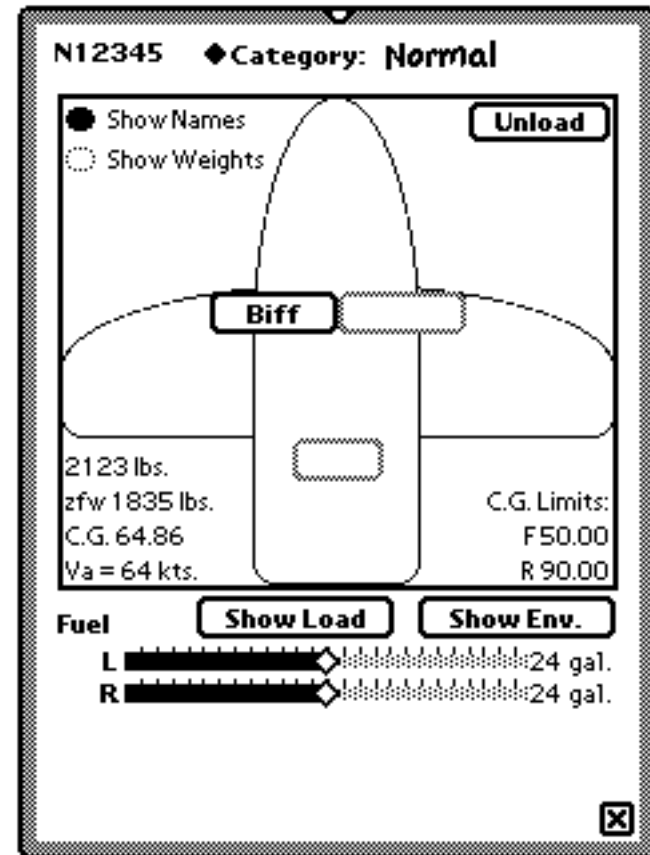

Figure 34
Weight and Balance: Load View

To select an operation category, **tap the category selector** at the top of the view, and select a category from the pop-up menu. See Figure 35.



Figure 35

Weight and Balance: Selecting the Category

Tap a seat button or baggage compartment to enter a load for that station. See Figure 36. In the view that appears, drag the slider to set a weight for that station. (You can use the + and - buttons to fine-tune the weight value.



Figure 36

Entering a Station Weight

If it's necessary to change the range for the slider, tap the labeled arrows.

Optionally, you can enter a name in the space provided. The most recently used names and their associated weights are remembered, and can be recalled if you tap on the "Name" label. See Figure 37.

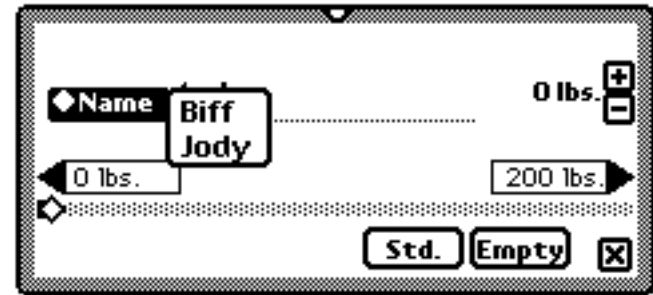

Figure 37

Selecting a Remembered Weight

Once a weight value has been entered, you can tap the close box to enter that weight (and optional name) into the station, and return to the weight and balance screen.

Alternatively, you can tap the Empty button to enter a weight of zero and return to the weight and balance screen. Tap the Std. button to enter an FAA standard passenger weight of 170 lb. and return to the weight and balance screen.

Back at the weight and balance screen, tap the Show Env. button to display a graphical representation of the current CG and its relation to the CG envelope. See Figure 38. Tap the Show Load button to switch back to a display of the aircraft's loading.

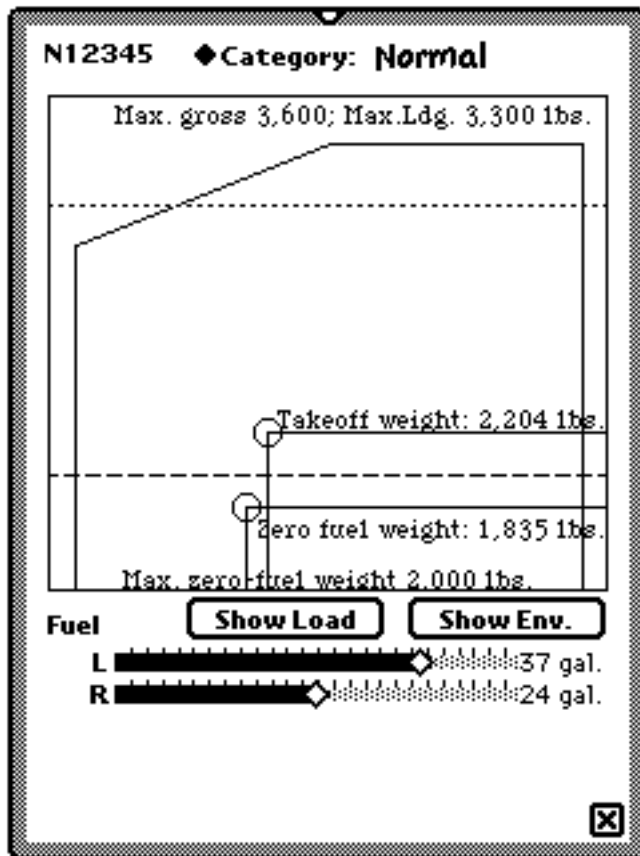

Figure 38
Weight and Balance: Envelope View

Drag the fuel sliders to adjust the amount of usable fuel in each tank.

When the aircraft loading is displayed, maneuvering speed (V_a) is displayed for the currently-specified weight. Tap the **Show Names** or **Show Weights** buttons to choose to show either the name or the weight associated with each filled station. Tap the **Unload** button to empty all the aircraft stations. See Figure 34.

Tap the close box to return to the main screen.

Using the Zulu Clock

On both the main screen and the flight plan view, a Zulu clock is displayed, showing the current date and time in Universal Coordinated Time (UTC). See Figure 39.



Figure 39
The Zulu Date and Time Clock

Tap on this clock to open a conversion table for the current location. The current hour is marked with a box around the entry in the table. See Figure 40.

For San Francisco:	
12am= 08Z	12pm= 20Z
01am= 09Z	01pm= 21Z
02am= 10Z	02pm= 22Z
03am= 11Z	03pm= 23Z
04am= 12Z	04pm= 00Z
05am= 13Z	05pm= 01Z
06am= 14Z	06pm= 02Z
07am= 15Z	07pm= 03Z
08am= 16Z	08pm= 04Z
09am= 17Z	09pm= 05Z
10am= 18Z	10pm= 06Z
11am= 19Z	11pm= 07Z
Sunrise: 7:20 am	
Sunset: 4:53 pm	
Civil twilight: 5:23 pm	

Figure 40
The Zulu Conversion and
Sunset/Sunrise Table

Also displayed are sunrise, sunset, and civil twilight times for the current location. (You can change the current location using the Time Zones icon in the Newton's Extra's drawer.)

Using the Flight Plan Display

From the main screen, tap the **Plan** button to display a flight plan summary. Items are listed in the standard order for filing a flight plan; you might use this view to help you file a flight plan by telephone. See Figure 41.

1. Type (VFR, IFR)
2. Aircraft identification: N12345
3. Aircraft type/special equipment: PA28/A
4. True airspeed (kts): 120
5. Departure point: SFO: San Francisco Intl
6. Departure time ◆
7. Cruising altitude ◆
8. Route of flight ◆
9. Destination: SAC: Sacramento Executive
10. Estimated time enroute: 34 minutes
11. Remarks ◆
12. Fuel on board (hours, minutes)
13. Alternate airport(s) ◆
14. Pilot's name, address, telephone, and a/c home base SFO
15. Number aboard: 1
16. Color of aircraft: Turquoise/Orange
17. Destination contact/telephone (optional) ◆
◆ 8 21:34 UTC

Figure 41
The Flight Plan View

You may edit the flight plan fields marked by a diamond character to add extra information to your flight plan. Tap on a line showing a diamond to display an editing slip for that flight plan field. See Figure 42.

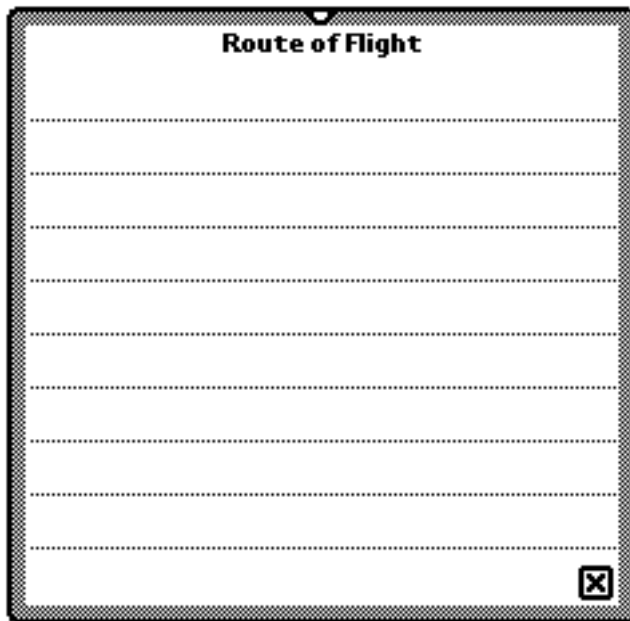

Figure 42
Annotating a Flight Plan Field

A copy of the flight plan may be exported to the Newton Notepad (and from there may be printed, faxed, or otherwise manipulated). **Tap on the action button and select Export to Notes** to copy the flight plan to the Notepad as a new note. See Figure 43.



Figure 43
Exporting a Flight Plan to Notes

Tap the close box to return to the main screen.

Figuring Density Altitude

From the main screen, **tap the D.Alt button** to display a density altitude computer. See Figure 44. **Drag the appropriate sliders** to indicate the altimeter setting, indicated altitude, outside air temperature, and calibrated airspeed (optional).

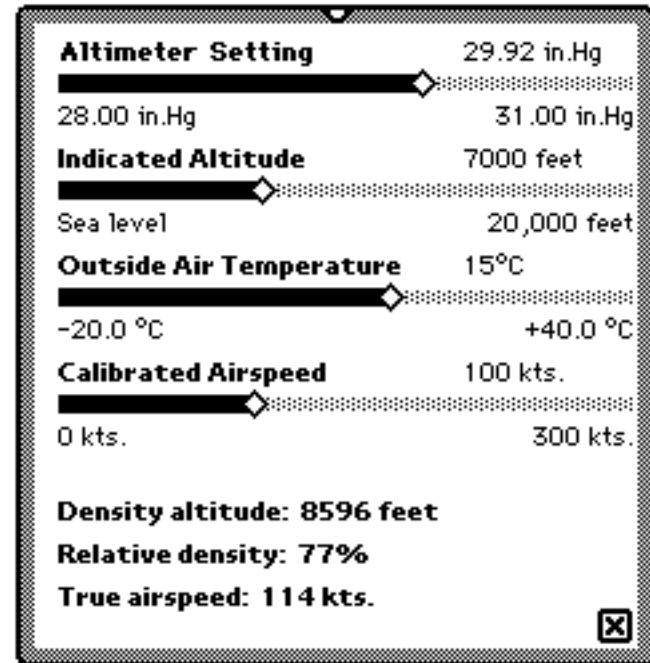

Figure 44
The Density Altitude Computer

Density altitude, relative density (expressed as a percentage), and true airspeed are displayed. Note that the true airspeed value corresponds to the calibrated airspeed indicated in this view; it has no relation to the true airspeed value used for the main screen's flight plan.

User Preferences

To edit the user preferences, tap the **Edit** button and tap **"Preferences"** from the pop-up menu. See Figure 45.

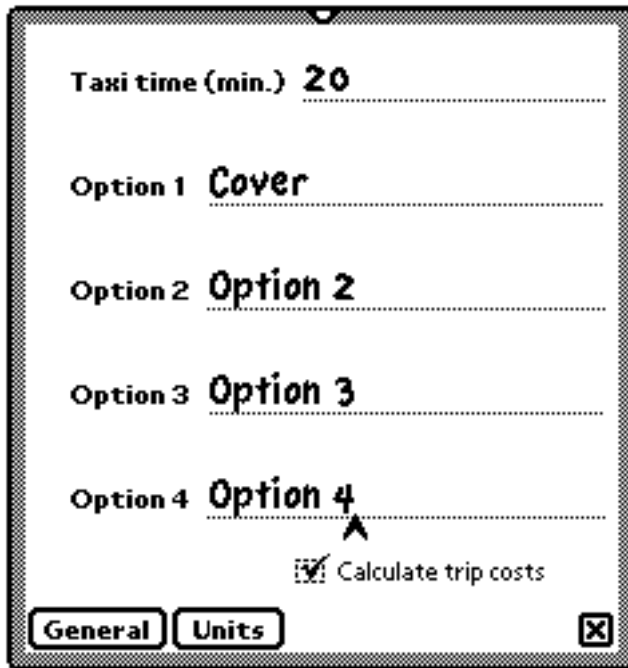

Figure 45
User Preferences: General

The first field in the user preferences is minutes of taxi time. This value is used only for computing the estimated flight cost, and is meant to cover climb and approach time, as well as time spent taxiing.

The next four fields are for user-specified aircraft equipment. Whatever you write in these fields is used to label the bottommost four check boxes in

the aircraft equipment view. (A typical use for these fields would be to track which aircraft at your favorite FBO have external covers, tow bars, engine heaters, or other options that are important to you.)

The last field in the user preferences is a check box for calculating trip costs. Uncheck this check box if you'd rather not know what a flight will cost.

Tap the **Units** button to select preferences for U.S. or metric units. See Figure 46.

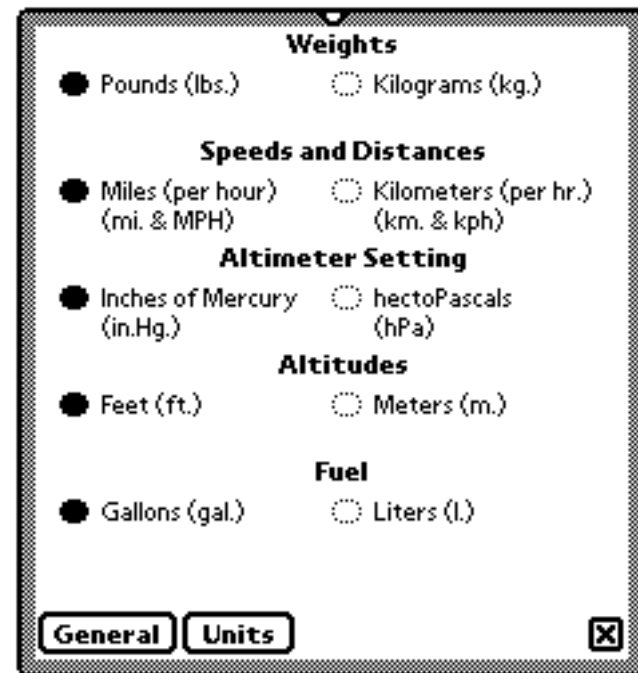

Figure 46
User Preferences: Units

Five separate units may be specified, as follows:

Weights: For weight and balance calculations, uses either U.S. pounds (weight), abbreviated “lb.,” or kilograms, abbreviated “kg.”

Speeds and Distances: All distances are measured in nautical miles (NM), and all airspeeds, ground speeds, and wind speeds are computed and displayed in nautical miles per hour (knots). Distances, airspeeds and ground speeds are *also* shown in units you select. The left-hand selector specifies distances in statute miles (mi.) and speeds in statute miles per hour (MPH); the right-hand selector specifies distances in kilometers (km) and speeds in kilometers per hour (kph).

Altimeter Setting: For density altitude computations, select whether you wish to enter altimeter settings in either inches of mercury (in.Hg.) or hectoPascals (hPa). HectoPascals and millibars represent the same unit.

Altitudes: For density altitude computations, altitudes can be entered and displayed either in feet (ft.) or meters (m.).

Fuel: Fuel quantities can be entered and displayed in either U.S. gallons (gal.) or litres (l.). This setting also determines how oil levels are entered and displayed. If U.S. gallons is selected for fuel, oil levels are entered and displayed in U.S. quarts (qt.); otherwise, if fuel levels are specified in litres, oil levels are in litres as well.

Tap the close box to return to the main screen.

Contacting Us

Got a comment or a question about Newton Aviator, or even a bug to report? Send us your feedback at

`NewtonAviator@pobox.com`

We'd love to hear from you!

Be sure to check our web site from time to time for new products and information of interest:

<http://www.pobox.com/~newtonaviator>

Newton Aviation Software

14 Abbott St.

Wellesley, MA 02181

781-235-8007